

Cole-Parmer®

RS-250 Series Reaction Station

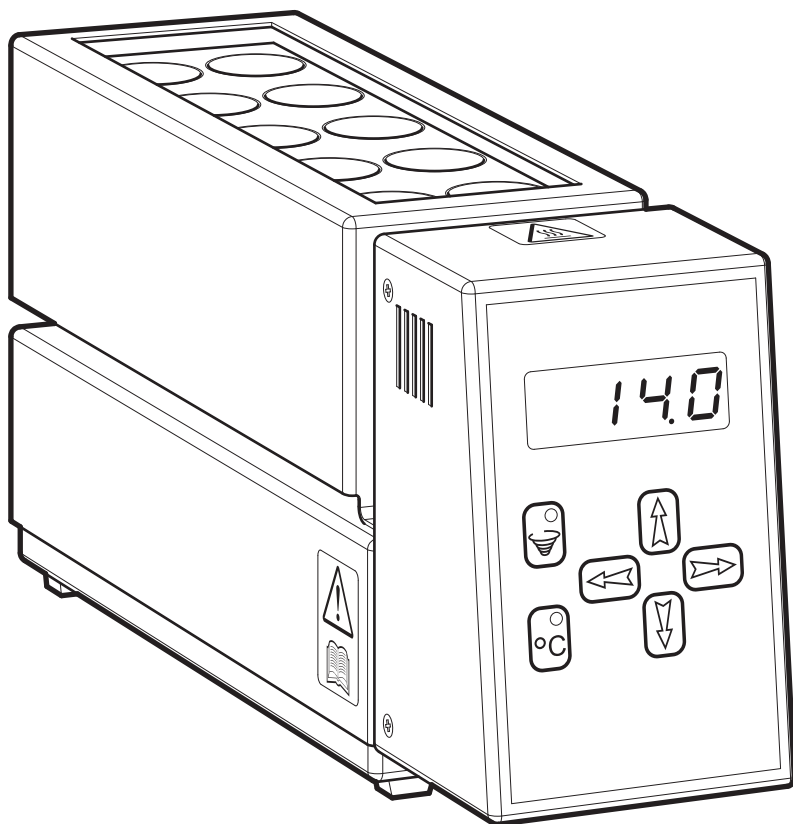

Instruction Manual
M7239 Version 4.6

Cole-Parmer®
essentials

Please take your time to read this Instruction manual in order to understand the safe and correct use of your new Cole-Parmer product.

It is recommended the responsible Body for the use of this equipment reads this instruction manual and ensures the user(s) are suitably trained in its operation.

Contents	Page
Section 1 Introduction	3
Section 2 Symbols and using this Instruction manual	4
Section 3 Safety Information	5
Section 4 Unpacking and Contents	7
Section 5 Installation	8
Section 6 Environmental Protection	9
Section 7 Equipment Operation	10
Section 8 Technical Specification	16
Section 9 Maintenance	18
Section 10 Spares and Accessories	20
Section 11 Customer Support	20
Section 12 Notes	21
Declaration of Conformity	23

© The copyright of this instruction manual is the property of Antylia Scientific Limited. This instruction manual is supplied by Antylia Scientific Limited on the express understanding that it is to be used solely for the purpose for which it is supplied. It may not be copied, used or disclosed to others in whole or part for any purpose except as authorised in writing by Antylia Scientific Limited. Antylia Scientific Limited reserves the right to alter, change or modify this document without prior notification.

In the interest of continued development Antylia Scientific Limited reserve the right to alter or modify the design and / or assembly process of their products without prior notification.

This product is manufactured in Great Britain by Antylia Scientific, part of the Antylia Scientific Group of companies.

Antylia Scientific Ltd.

Beacon Road,
Stone,
Staffordshire,
ST15 0SA,
United Kingdom
Tel: +44 (0)1785 812121

Note: All illustrations in this document are for reference only

1. INTRODUCTION

- 1.1. This product is designed to meet the demands of today's modern laboratory and has been meticulously designed to provide years of service when used as described in the following pages. This product is a 10-positioned heat and stir reaction station designed for use with 25 mm diameter glass vessels or 24mm diameter glass vessels with sleeve inserts.
- 1.2. At the heart of this product is an innovative, firmware package designed to provide enhanced, accurate temperature control of the block or vessel. Temperature is sensed by a high precision platinum sensor embedded within the vessel block. A microprocessor constantly monitors temperature change many times per second. The products temperature range is from ambient to 150°C.
- 1.3. Linked DC motors provide optimum speed control and sensitivity to drive the stir facility. High performance magnetic sensors carefully measure speed control via a feedback loop controlled by quartz oscillator and a microprocessor. The stir speed range is 400 – 2000rpm.
- 1.4. The vessel block is aluminium with a Teflon coating. The raised case walling reduces heat loss, which improves energy efficiency and adds to the protection of the user.

2. SYMBOLS AND USING THIS INSTRUCTION MANUAL

2.1. Throughout this Instruction book the following symbols are shown to identify conditions which pose a hazard to the user or to identify actions that should be observed. These symbols are also shown on the product, or its packaging. When a symbol is shown next to a paragraph or statement it is recommended the user takes particular note of that instruction in order to prevent damage to the equipment or to prevent injury to one's self or other people.

The Responsible Body and the Operator should read and be familiar with this Instruction manual in order preserve the protection afforded by the equipment.

To prevent injury or equipment damage it is the manufacturer's recommendation that all persons using this equipment are suitably trained before use.

2.2. Symbols Defined



Caution, risk of danger. See note or adjacent symbol.



Protective conductor terminal to be earthed. **(Do not loosen or disconnect).**



Caution / risk of electric shock



Recyclable Packing Material



Do not dispose of product in normal domestic waste.



Caution. Hot surface.



This symbol denotes the use of the heating function



This symbol denotes this section of the fascia is designated for the control of the stirring function.



This symbol denotes this section of the fascia is designated for the setting and control of the temperature



These symbols are designated for the left and right arrow functions when setting the product



These symbols are designated for the up and down arrow functions when setting the product



Bio Chemical Hazard. Caution required. Will require decontamination.



Refer to Instruction book.

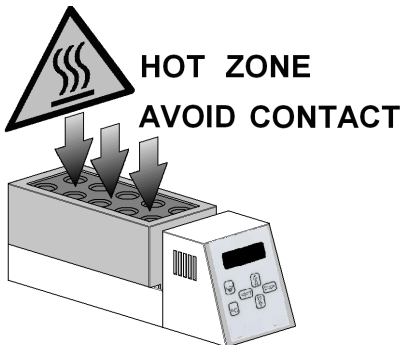

3. SAFETY INFORMATION

This product has been designed for safe operation when used as detailed in accordance with the manufacturer's instructions.



ATTENTION:- The product will not restart after a mains electrical supply interruption once the supply has been returned.

NOTE: Failure to use this equipment in accordance with the manufacturer's operating instructions may compromise your basic safety protection afforded by the equipment and may invalidate the warranty / guarantee. The warranty / guarantee does not cover damaged caused by faulty installation or misuse of the equipment.

3.1. Prevention of Fire and Electric shock.



To prevent a risk of fire or electric shock, **do not** open your product case without authorisation. Only Qualified Service Personnel should attempt to repair this product.



Replace fuses only with the type as listed in section, 'Technical Specification' (See fuse type and rating).



Ensure the Mains Power Supply conforms to rating found on the data plate located on the right hand side of this product.



Never Operate this equipment without connection to earth / ground. Ensure the mains supply voltage is correctly earthed / grounded in accordance with current area legislation.

3.2. General Safe Operating Practice.



Always follow good laboratory practice when using this equipment. Give due recognition to your company's safety and legislative health & safety procedures and all associated legislation applicable to your areas of operation. Check laboratory procedures for substances being heated and ensure all hazards (e.g. explosion, implosion or the release of toxic or flammable gases) that might arise have been suitably addressed before proceeding. When heating certain substances the liberation of hazardous gases may require the use of a fume cupboard or other means of extraction.



Do not position the product so that it is difficult to disconnect from the mains supply.



Do not touch the heating block or any glass vessel whilst in use.



Do not lean or stretch over equipment, glassware and fixings when in use.



Do not immerse unit in water or fluids.



Do not spill substances onto the heating block. If spillage does occur, disconnect unit from mains supply and follow instructions as detailed in Maintenance. (Section 9).



Do not cover this product whilst in use. **Do not** block or obstruct ventilation slots / airways.



Do not leave equipment switched on without a charged flask(s).



It is not recommended to leave any heating apparatus unattended during operation.



Only use Original Equipment manufacturers spares and accessories. Ref Section 10.



This equipment will generate magnet fields. Keep all metal objects and magnetic data devices (e.g. credit cards) away from the stirrer unit.



The equipment is not spark, flame or explosion proof and has not been designed for use in hazardous areas in terms of BSEN 60079-14:1997. Keep flammable, low flash point substances away from the apparatus.



Do not operate or handle any part of the product with wet hands.



Keep the Mains cord and moulded IEC plug and lead set away from the heating surface.

4. UNPACKING AND CONTENTS

4.1. Please check the contents of your carton against the diagram.

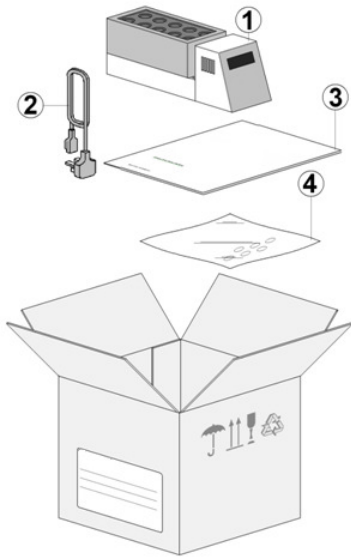

Item	Description	Qty
1	RS-250D-25 Product	1
2	Mains Cord and Lead set <i>(illustration only)</i>	A/R
3	Instruction manual	1
4	Stir Bars (Pkt 10)	1





For future reference please record your products Serial and Model Numbers.	Serial Number	Unit Model/Cat Number
-----------------------------------------------------------------------------------	----------------------	------------------------------

5. INSTALLATION



5.1. Electrical safety and Installation

5.1.1. This equipment is designed for safe operation under the following conditions:-

- Indoor use.
- Altitude up to 2000 meters.
- Temperatures between 5°C and 40°C.
- Maximum relative humidity 80% for temperatures up to 31°C decreasing linearly to 50% relative humidity at 40°C.
- Mains supply voltage fluctuations up to $\pm 10\%$ of the nominal voltage.
- Transient overvoltages typically present on the mains supply.
(Over voltage category II).
- Applicable rated pollution degree 2.

- 5.2.  This equipment must be earthed / grounded to a fixed earth / grounded mains socket outlet. The mains supply is to be earthed / grounded in accordance with current legislation.
- 5.3. Ensure only the correct rated mains input fuses are fitted. (Where applicable ensure the correct Mains cord and moulded IEC plug and lead set fuse if fitted). See Technical Specification Section 8 of this Instruction manual.
- 5.4. Check the voltage on the data label of this product. Ensure the rating conforms to your local supply.
- 5.5. It is recommended this product be connected to a mains supply source which incorporated a RCD or GFCI device.
- 5.6.   Do not install this product or accessories on a surface which may become wet or flooded.
- 5.7. The unit is supplied with a moulded mains cord and plug set wired as follows:-
Green /Yellow or Green = Earth / Ground 
Blue or White = Neutral
Brown or Black = Live / line hot.
- 5.8.  Install equipment is used on a clean, dry, non-combustible, solid work surface with at least 300mm suitable clearance all around from other equipment / objects.

6. ENVIRONMENTAL PROTECTION

- 6.1. Maximum consideration has been given to environmental issues within the design and manufacturing process without compromising end product performance and value.
- 6.2.  Packaging materials have been selected such that they may be sorted for recycling.
- 6.3.  At the end of your product and accessories life, it must **not be** discarded as domestic waste. Ref: EU Directive 2002/96/EC on Waste Electrical and Electronic Equipment Directive (WEEE). Please contact your distributor / supplier for further information. For end users outside of the EU consult applicable regulations.
- 6.4. This product should only be dismantled for recycling by an authorised recycling company.



This product and accessories must be accompanied by a completed Decontamination Certificate prior to any Disposal. Copies of the Certificate are available from Distributor/Manufacturer.

7. EQUIPMENT OPERATION

7.1. The illustration below shows the general layout of the RS-250D-25.

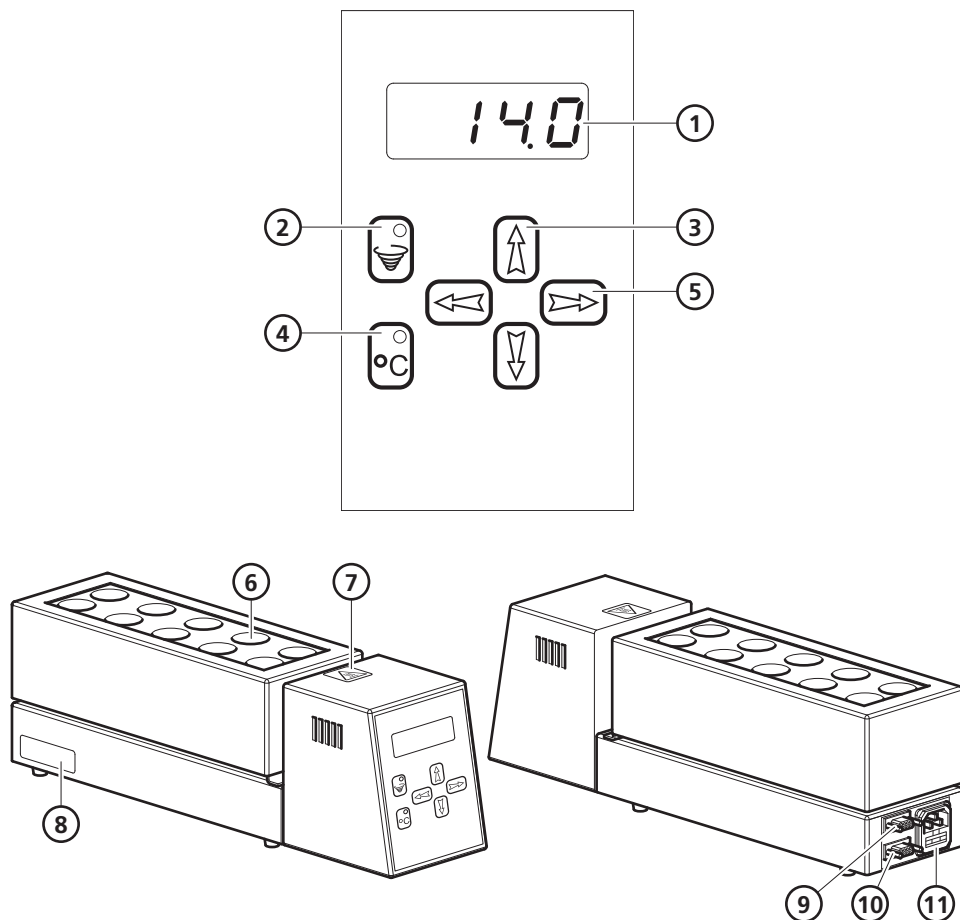

- 1 Display
- 2 Stir facility on/off button
- 3 Up/down arrow function select and set button
- 4 Temperature on/off button
- 5 Left/right arrow function select and set button
- 6 Reaction block chamber
- 7 Hot surface warning label
- 8 Rating plate
- 9 RS232 9-way connection socket
- 10 RS485 9-way connection socket
- 11 IEC socket with fuse protection

- 7.2. Plug the mains cord with the moulded IEC plug into the IEC socket of the unit. Connect the mains plug to the correct voltage mains supply. Check data plate for correct voltage input.
- 7.3. The display will perform a warm up and self check prior to displaying the present temperature for the reaction block.



Sound Indication: - A short 'Beep' gives indication of parameter change. Long 'Beep' gives warning of error.

7.4. Main Screen

7.4.1. The following screen shot shows the actual block temperature. This is likely to be at ambient temperature when the RS-250D-25 is first powered up from cold. The "T" in the display shows the mode for setting the temperature. The "S" in the display shows the mode for setting the stir speed. The "t" in the display is used to set the count down time left before the heating function is turned off. Actual block temperature is displayed in degrees Centigrade. Stir speed is measured in RPM and shown with the "s" symbol denoting Speed.

Note: If 10 seconds elapse without a key being pressed the display is set to return to the main display screen.

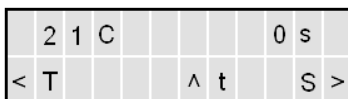

7.5. Setting and Operating the Heater Function

7.5.1. From the main display screen press the < key to go into Temp setting screen.

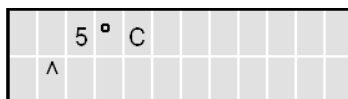

7.5.2. Press the ^ or v to make the 100's selection. Press the > key to go into 10's set screen.

First time factory default setting to be 5°C.

Last user setting will be displayed.

7.5.3. Press the ^ or v to make the units selection. Press the > to go back to main display screen.

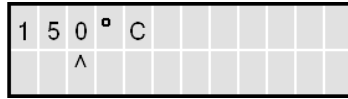

7.5.4. To commence heating press the heating button. To turn off the heating function press the button one once again.



Note: The main display screen will always show the actual temperature of probe or block PT100. During the heating process the red LED found in the center of the Heater on/off key will flash. When the set temperature has been reached the flashing will stop and remain constantly illuminated.

When adjusting the set temperature from a reached temperature to another, to accommodate over / under temperature oscillation the LED will not recommence flashing until a temperature of $\pm 10^{\circ}\text{C}$ of the original set temperature has been selected.

7.6. Stirrer Functions

7.6.1. From the Main display screen press the > key to enter the Stir speed selection screen.

7.6.2. Press the > or < to make the 1000' 100' 10 and units selection. Press the ^ and v buttons to select the values.

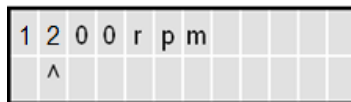

Note: The maximum settable stir speed value is 2000 rpm.

7.6.3. Press the > from the units setting to enter the stir speed ramp mode.

7.6.4. Using the > or < to make the 1000' 100' 10 and units selection. Press the ^ and v buttons to select the ramp speed values.



Example: In the example, the stir speed will ramp up at the rate of 400rpm per minute. So if a stir speed of 1200 rpm was set, it would take approximately 2 minutes to ramp from start to 1200rpm.

7.6.5. Repeatedly press the > button to exit the stir speed setting mode.

7.6.6. To commence stirring press the stir button. To stop stirring press the stir button once again.



7.7. Timer set function

The maximum time setting is 99 hours and 59 minutes.

Note: Once the timer has been set it will not commence count down until the Heater on/off key is activated.

7.7.1. From the main display screen press the ^ key.

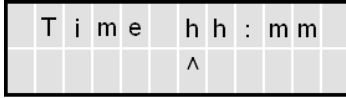

7.7.2. Press the ^ or v to make the 10's hours selection. Press the > key to go into unit hours selection screen.

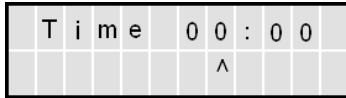

7.7.3. Press the ^ or v to make the 10's minutes selection. Press the > to go back to main display screen.

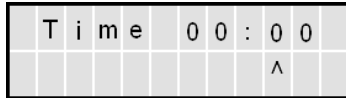

Note: If 10 seconds elapse without a key being pressed the display is set to return to the main display screen.

7.7.4. With the timer set the front screen will display only count down hours until only minutes are left on the time counter, then minutes are to be displayed. The front screens will look like this. h denotes hours and m denotes minutes. When the time counter reaches zero the heaters are turned off. The Heater on Red LED is extinguished and the main display screen reverts to ^t. A 1 second beep is to be sounded when heaters are turned off in timer mode.



Note: The timer will not commence count down until the set temperature has been reached and the Red LED is constant.

7.8. RS232 Operation

7.8.1. When the unit is coupled to an external host robotic system that is either RS485 or using GSI0C protocol through the RS485 socket the following screens are seen.

7.9. STEM@ Protocol (RS232)

Stem command SET can be operated using RS232.
Unit address 40. Baud rate is 9600, N, 8, 1.

Command set as follows: -

LK*	Local Keypad	(0 or 1)
SE*	Stirrer enabled	(0 or 1)
SR*	Stir speed ramp rate	(400 to 2000 per min)
SS*	Stir Speed (RPM)	(400 to 2000)
TE*	Thermal control enabled	(0 or 1)
TT*	Target temperature (°C)	(0.0 to 150)
TR*	Temperature Ramp rate (°C/min)	(0.0 to 5.0)

Note: For TR 0.0 indicates no control. *Denotes variable parameter

Query command set

QC	Request commanded variables
QF	Request system principal fixed values.
QM	Request measured data

Using a suitable terminal, type in and test some of the commands and query set, STEM protocol.

Examples of STEM Command protocol used

"<CR>" Is a carriage return character.

Type in: >40 SE1 #0000 <CR>

Response: <40.00 OK <CR>

Result: Stirrer enabled (LED for stirrer ON< RS600 will commence stirring).

Type in: >40 SE0 #0000 <CR>

Response: <40.00 OK <CR>

Result: Stirrer disabled (LED for stirrer OFF, RS600 will stop stirring).

Type in: >40 TT123,4 TE1 #0000

Response >40,00 OK <CR>

Result Target temperature set to 123, 4°C, thermal control enabled (LED for ON< temperature will begin to raise block temperature).

Type in: >40 SS2000 SE1 SR2 #0000 <CR>

Response: <40,00 OK <CR>

Result: Stirring enabled, stirring speed set to 2000 rev/min, Stirrer ramp rate set to 2, (Stirring speed will steadily increase to 2000 rev/ min over 2 minutes).

GSIOC Interface module for RS-250D-25

The interface module is designed to comply with the specifications in the Gilson document "GSIOC technical Manual" dated March 1999.

Buffered Commands:

Command	Meaning
----------------	----------------

T1	Turn on thermal control
T0	Turn off thermal control
S1	Turn on stirrer, start speed ramp-up
S0	Turn off stirrer, reset speed ramp.
P#	Set temperature set point to #°C (Range 5 to 150°C)
V#	Set stir speed target to # rpm (Range 400 to 2000)
R#	Set stir ramp control to # rpm/min (Range 0 to 2000 – 0 means no ramp control).
L1	Lock local keypad
L2	Unlock local keypad
Z#	Set GSIOC address

Immediate commands

Command	Meaning	Return Value
----------------	----------------	---------------------

\$	Reset unit	\$
W	Report current temperature	# (# is temperature in °C)
Q	Report set temperature set point	# (# is set point in °C)
A	Report for stir speed	# (# is set speed in rpm).
B	Report set ramp time	# (# is set ramp time in seconds).
S	Report status	xy X is the 'ready' status; it will be "1" if the unit is not ready to accept a command and "0" if the unit is ready. Y is the 'error' status; it will be "12" if the last command was not accepted, otherwise it will be "0"
K	Report keypad lock status	x X is "1" for locked, and "0" for not locked.

Notes:

- Before taking control of the unit using GSIOC, the 'L1' command must be sent to lock the local keypad. When control is released, 'L0' may be sent to unlock the keypad and allow manual control.
- Numbers, represented by "#", are decimal numbers of up to four digits.

8. TECHNICAL SPECIFICATION

Mains supply voltage	100-115V~AC 50/60 Hz – (PS80033) 230V~AC 50/60 Hz – (PS80010)
HH179(S)	Mains cord and moulded IEC plug and lead set cable (UK) 10A BS1362
HH180(S)	Mains cord and moulded IEC plug and lead set cable (Europe)
CRM6288	Mains cord and moulded IEC plug and lead set cable (USA)
Maximum load	100-115V = 330W 230V = 330W
Operating ambient temperature	5°C to 40°C
Heating temperature range	Ambient + 5 to 150°C
Display	2 x 12 back lit LED
Fuse rating	100-115V = F8A 20mm x 5mm Quickblow 230V = F5A 20mm x 5mm Quickblow
Number of vessel positions	10
Vessel diameter	24 - 25mm – may be reduced by the use of optional adapter sleeves
Well diameter	24.5 - 25.5mm
Stirring rate	Off and variable 400 to 2000 RPM
Stirring speed accuracy	±0.5%
Temperature stability	±1.0°C (Still air, under no load condition)
Interface	RS232, RS485
Connection	9-way 'D' type socket / plug for connection to the serial port of a laboratory computer or liquid handling system

The Ingress protection rating for this product is classified as IPX1.

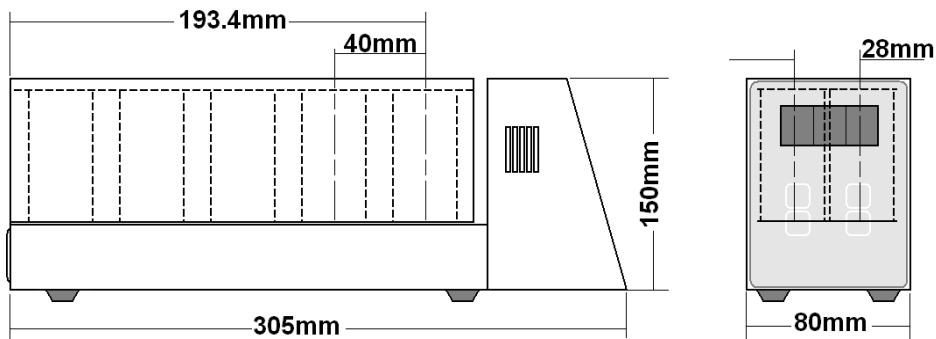

Emissions Classification. (115V Only)

Warning! Any modification or changes made to this device, unless explicitly approved by Antylia Scientific Ltd., will invalidate the authorisation of this device. Operation of an unauthorised device is prohibited under Section 302 of the Communications Act of 1934 as amended, and Subpart 1 of Part 2 of Chapter 47 of the code of Federal Regulations.

NOTE: This equipment has been tested and found to comply with the limits for a Class A digital device, pursuant to part 15 of the FCC Rules. These limits are designed to provide reasonable protection against harmful interference when the equipment is operated in a commercial environment. This equipment generates uses and can radiate radio frequency energy and, if not installed and used in accordance with the instructions, may cause harmful interference to radio communications. Operation of this equipment in a residential area is likely to cause harmful interference in which case the user will be required to correct the interference at their expense.

NOTE: (230V) Product is found to comply with the limits of Class B digital device, pursuant to part 15 of the FCC Rules.

Guidance notes

Class A Digital Device: A digital device that is marketed for use in a commercial, industrial or business environment, exclusive of a device which is marketed for use by the general public or is intended to be used in the home.

Class B Digital Device: A digital device that is marketed for use in a residential environment notwithstanding use in commercial, business and industrial environments. Examples of such devices included, but are not limited to, personal computers, calculators, and similar electronics devices that are marketed for use by the general public.

9. MAINTENANCE

9.1. General Information.



Unplug the unit from the mains voltage supply and allow it to cool before undertaking any maintenance tasks.



Maintenance should only be carried out under the direction of the Responsible Body, by a competent electrician. Failure to do so may result in damage to the product and in extreme cases be a danger to the end user.

With proper care in operation this equipment has been designed to give many years of reliable service. Contamination or general misuse will reduce the effective life of this product and may cause a hazard.

Maintenance for the unit should include:

- Periodic electrical safety testing (an annual test is recommended as the minimum requirement).
- Regular inspection for damage with particular attention to the mains lead and plug set.
- Routine cleaning of the equipment should be undertaken using a clean cloth.

DO NOT USE SOLVENTS FOR CLEANING ANY PART OF THIS EQUIPMENT.

9.2. Internal Fuse Replacement.

The mains fuse holder is located at rear your product. Refer to 'Fuse rating' in the Technical Specification section for correct fuse type and rating. Turn your product off and remove it from the mains supply. Open fuse draw and remove fuses. Fit replacement fuses and close the draw.

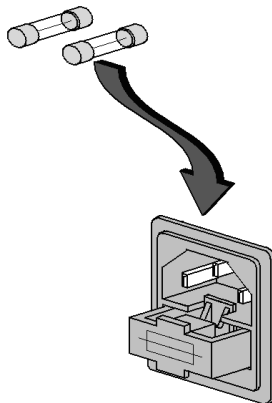

9.3 Servicing.

This product should be serviced by a Antylia Scientific Service Engineer or by an agent on behalf of the manufacturer. If in doubt please consult Customer Support. Refer to section 11.

9.4. Spillage and Decontamination.

In the event of spillage switch off and unplug this product from the mains electrical supply. Wipe off all excess liquid from the reaction block and surrounding area using an absorbent soft cloth. Allow sufficient time for any ingressed liquid to evaporate before commencing with use.

If in doubt please consult Customer Support. Refer to section 11.



If the equipment has been exposed to contamination, the Responsible Body is responsible for carrying out appropriate decontamination. If hazardous material has been spilt on or inside the equipment, decontamination should only be undertaken under the control of the Responsible Body with due recognition of possible hazards. Before using any cleaning or decontamination method, the Responsible Body should check with the manufacturer the proposed method will not damage the equipment.

Prior to further use, the Responsible Body shall check the electrical safety of the unit. Only if all safety requirements are met can the unit be used again. The above procedure is intended as a guide. Should spillage occur with a toxic or hazardous fluid then special precautions may be necessary.

Decontamination Certificate.

Note: In the event of this equipment or any part of the unit becoming damaged, or requiring service, the item(s) should be returned to the manufacturer for repair accompanied by a completed decontamination certificate. **Copies of the Certificate are available from Distributor/Manufacturer.**

At the end of life, this product must be accompanied by a completed Decontamination Certificate.

10. SPARES AND ACCESSORIES

Order Number	Description
HH179(S)	Mains cord and moulded IEC plug and lead set cable (UK) 10A BS1362
HH180(S)	Mains cord and moulded IEC plug and lead set cable (Europe)
CRM6288	Mains cord and moulded IEC plug and lead set cable (USA)
ATS10075	24 150mm SVL thread test tubes x10
ATS10377	SVL thread PTFE inerting caps x10
ATS10055	Small volume test tubes 24-16mm taper x10
ATS10056	Reducing sleeves for ATS10055 x10
ATS10101	Reducing sleeves for ATS10209 x10
ATS10209	24-11mm test tubes (1ml) x10
AZS4206	Stirrer bars 10 x 6mm x10
AZS4235	Stirrer bars 12 x 4.5mm x10
AT60067	Stirrer bars 14 x 4mm x10

Please contact your local sales specialist or email cpspares@antylia.com to enquire about available spares.

Please visit www.coleparmer.com for a full list of available accessories.

11. CUSTOMER AND TECHNICAL SUPPORT

For help and support in using this product, please contact Customer Services at the following address:

Antylia Scientific Ltd.
Beacon Road,
Stone,
Staffordshire,
ST15 0SA,
United Kingdom
Tel: +44 (0)1785 812121

Service: cpsservice@antylia.com
General enquiries: cpinfo@antylia.com
Order enquiries: cpsales@antylia.com
Technical support: cptechsupport@antylia.com

www.coleparmer.com

12. NOTES

12. NOTES

CE UK
CA This product meets the applicable CE Directives and UKCA Legislation for radio frequency interference and may be expected not to interfere with, or be affected by, other equipment with similar qualifications. We cannot be sure that other equipment used in its vicinity will meet these standards and so we cannot guarantee

that interference will not occur in practise. Where there is a possibility that injury, damage or loss might occur if equipment malfunctions due to radio frequency interference, or for general advise before use, contact the manufacturer.

Declaration of Conformity is available to view online at www.coleparmer.com

EU Representative address

Antylia Scientific GmbH
Futtererstraße 16
97877 Wertheim
Deutschland
Tel: +49 9377 9203-0
Email: sales@coleparmer.de

UK Representative address

Antylia Scientific
9 Orion Court
Ambuscade Road
Colmworth Business Park
St. Neots
PE19 8YX
United Kingdom
Tel: +44 (0) 1480 277339
Email: enquiries@antylia.com



WolfLabs

Pricing on any accessories shown can be found by keying the part number into the search box on our website.

The specifications listed in this brochure are subject to change by the manufacturer and therefore cannot be guaranteed to be correct. If there are aspects of the specification that must be guaranteed, please provide these to our sales team so that details can be confirmed.

www.wolflabs.co.uk

Tel : 01759 301142

Fax : 01759 301143

sales@wolflabs.co.uk

Please contact us if this literature doesn't answer all your questions.